

FILLING DOOR
NOT TO SCALE

TUNNEL DOOR
NOT TO SCALE

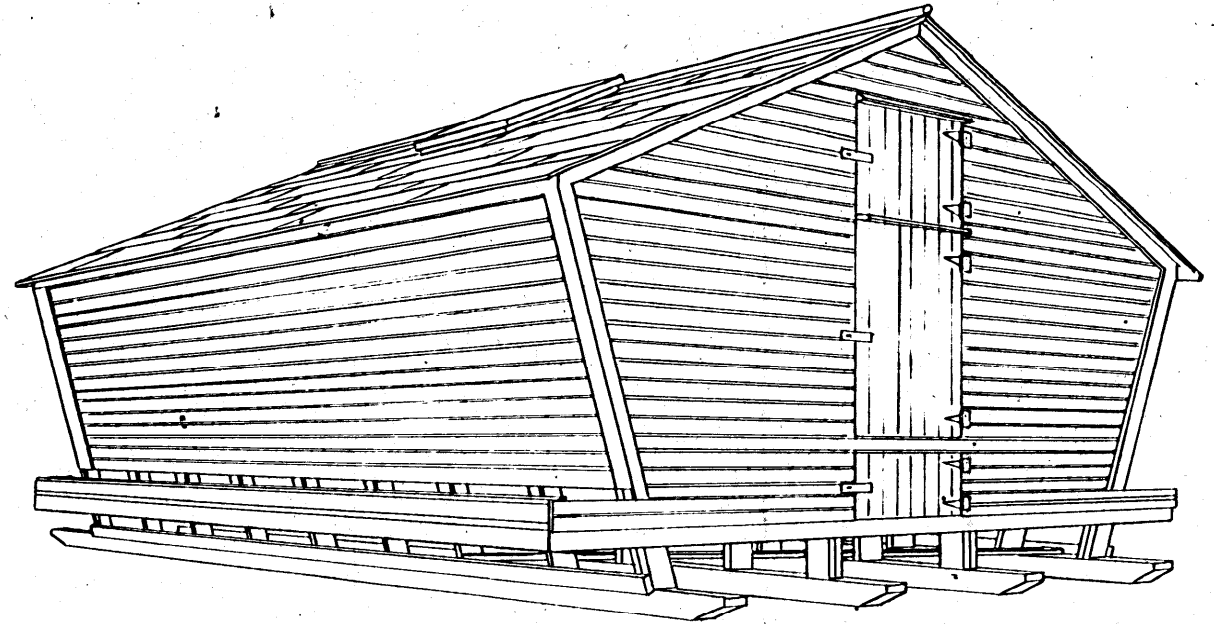

PERSPECTIVE
NOT TO SCALE

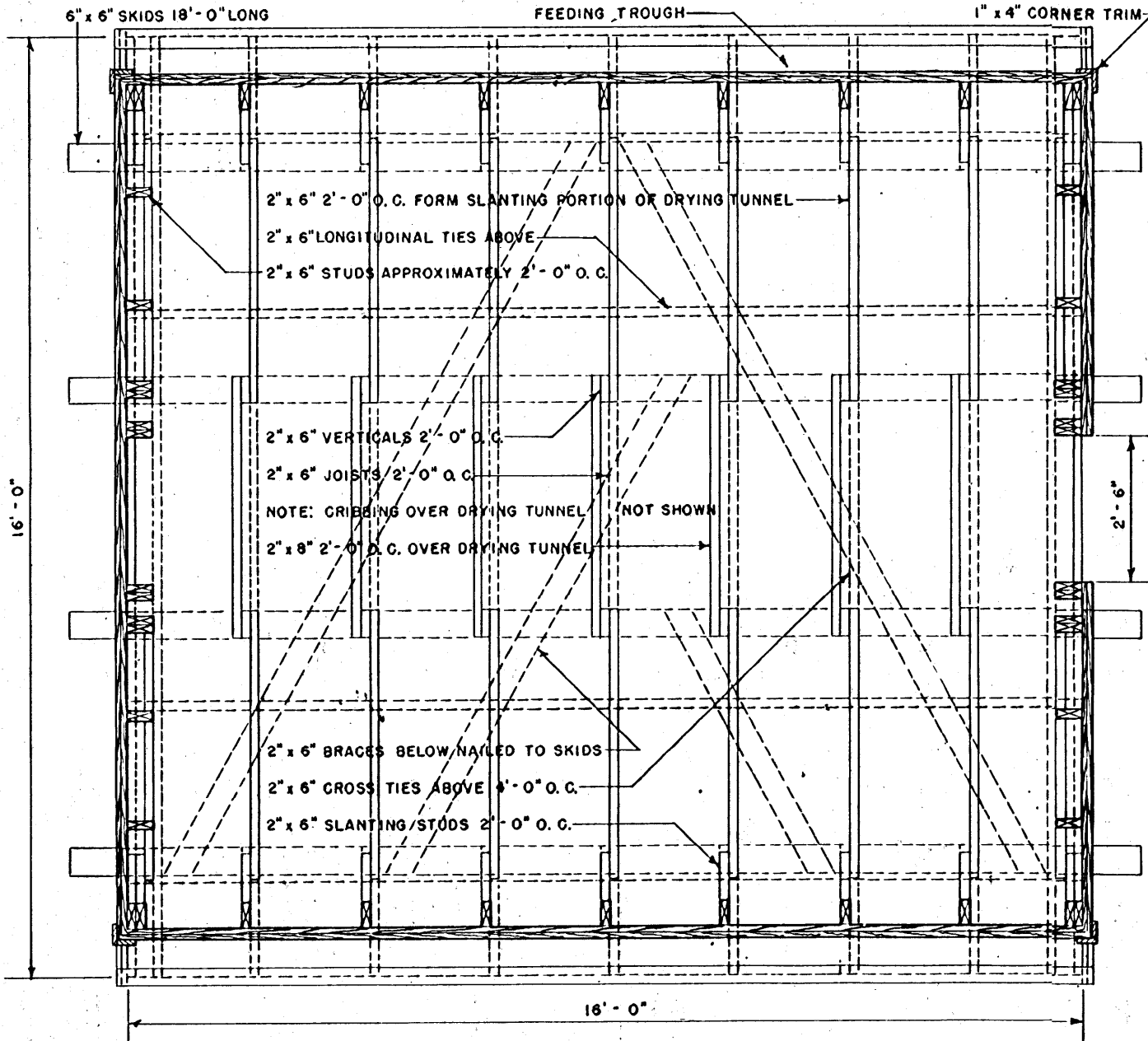

PLAN

SCALE - $\frac{3}{8}$ = 1'-0"

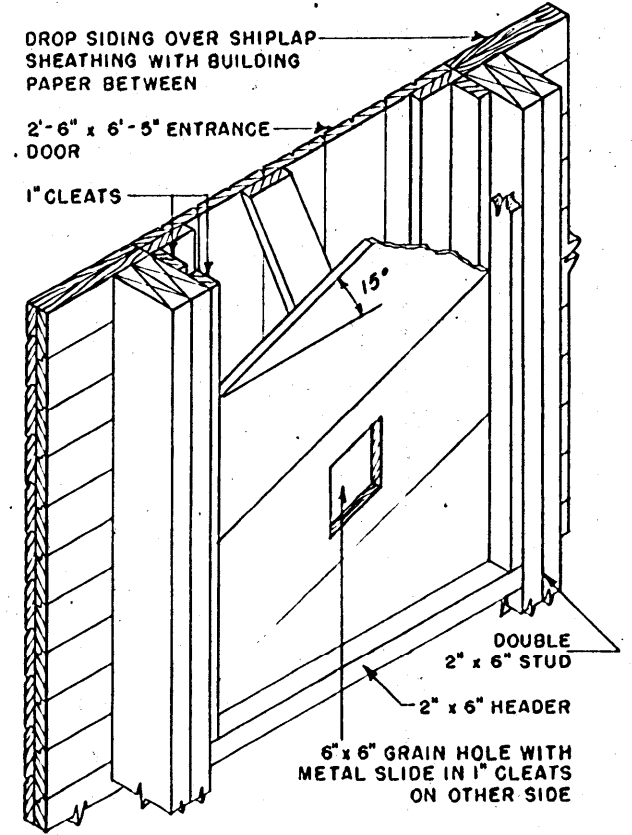

DETAIL AT ENTRANCE DOOR
NOT TO SCALE

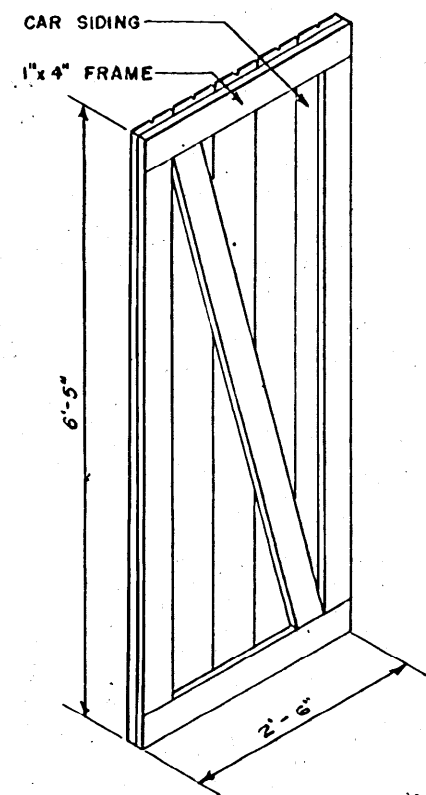

ENTRANCE DOOR
NOT TO SCALE

COOPERATIVE EXTENSION WORK IN
AGRICULTURE AND HOME ECONOMICS

AND
UNITED STATES DEPARTMENT OF AGRICULTURE COOPERATING

MOVABLE BEEF CATTLE FEEDER,
STORAGE & DRIER, GRAIN & EAR CORN

M.W.	EX. 5726	SHEET 1 OF 2
------	----------	--------------

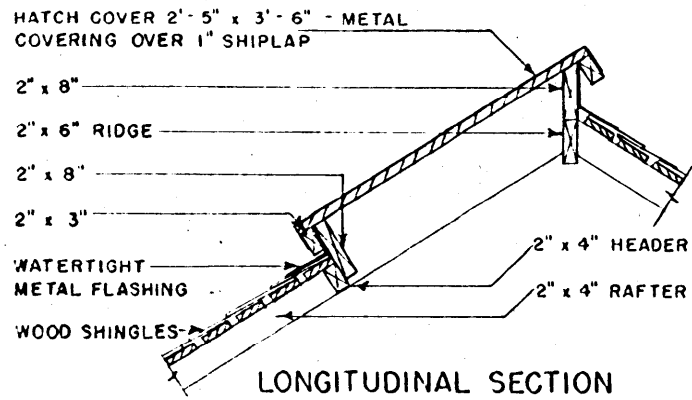

LONGITUDINAL SECTION

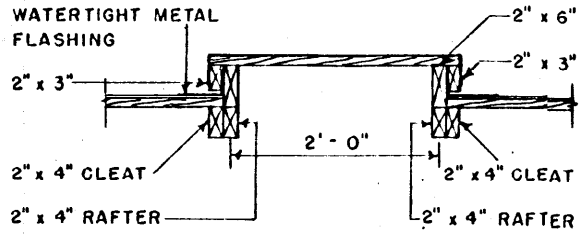

CROSS SECTION

HATCH DETAILS

SCALE - $\frac{1}{2} = 1'-0"$

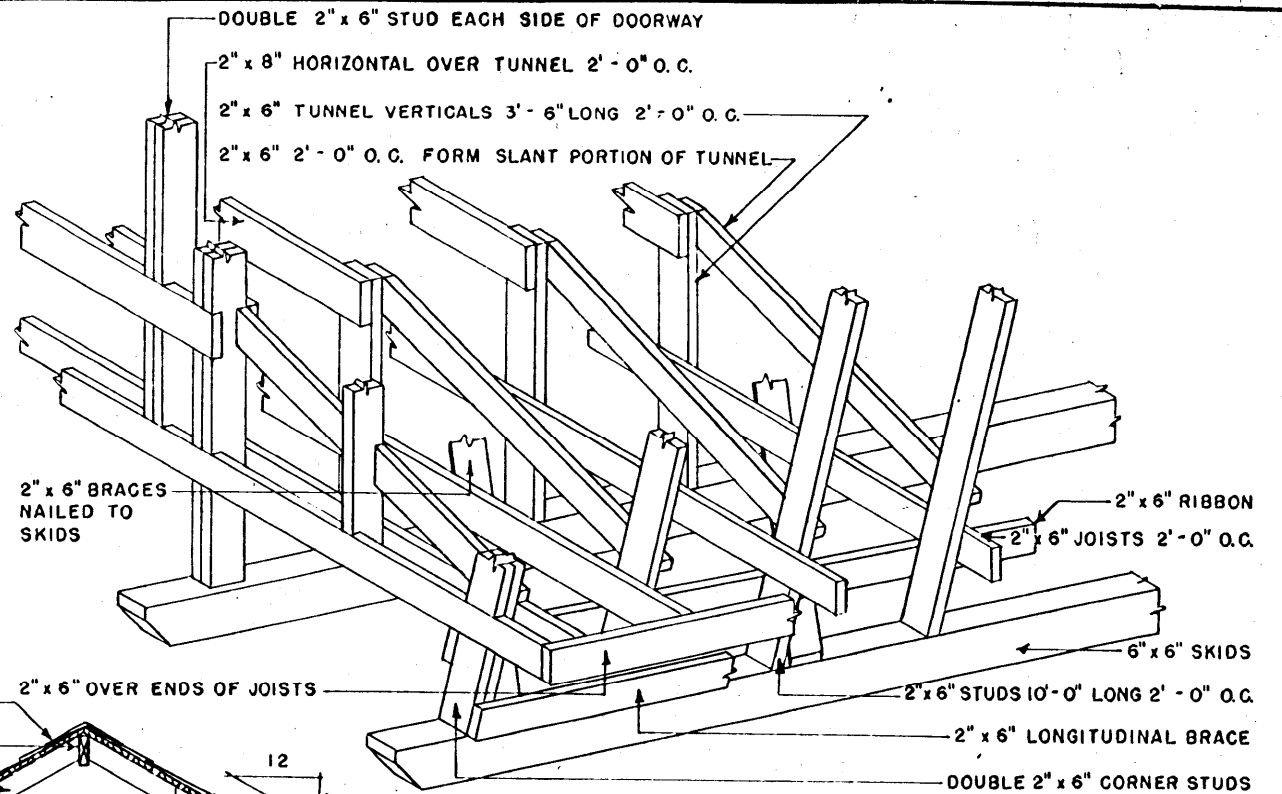

FRAMING DETAIL

NOT TO SCALE

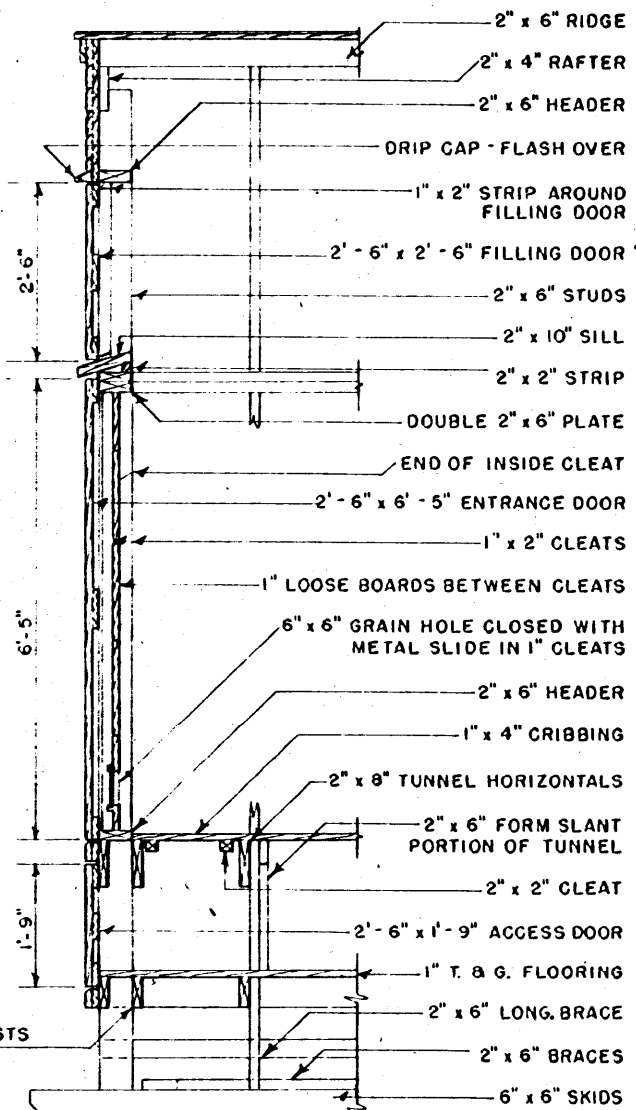

NOTE: ENTRANCE DOOR CAN BE PROVIDED IN BOTH ENDS IF DESIRED.

SECTION THROUGH END

SCALE - $\frac{3}{8} = 1'-0"$

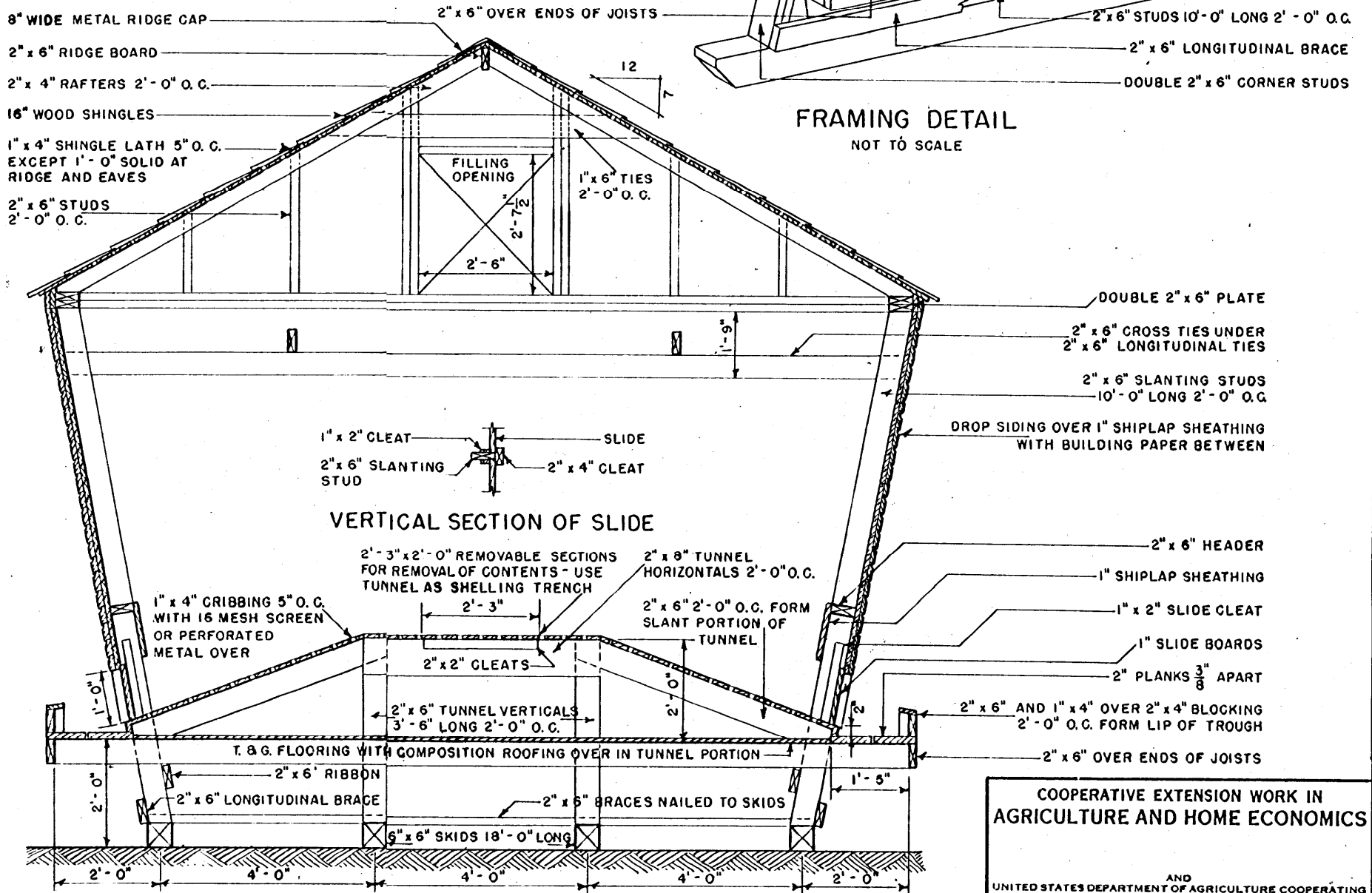

VERTICAL SECTION OF SLIDE

CROSS SECTION

SCALE - $\frac{3}{8} = 1'-0"$

COOPERATIVE EXTENSION WORK IN AGRICULTURE AND HOME ECONOMICS

AND UNITED STATES DEPARTMENT OF AGRICULTURE COOPERATING

MOVABLE BEEF CATTLE FEEDER, STORAGE & DRIER, GRAIN & EAR CORN

M.W. EX. 5726 SHEET 2 OF 2